

RECTIFICADORES NEUMÁTICOS



HYM AT-7032B



HYM AT-7033B



HYM AT-7032BK

1/4" 25.000 RPM



HYM AT-7033BK

1/4" 22.000 RPM



HYM AT-7032N



HYM NST-7032F

1/4" 25.000 RPM 4 VEL.

RECTIFICADORES NEUMÁTICOS



HYM AT-7032NK

1/4" 25.000 RPM 4 VEL.



HYM NST-7032MK



HYM NST-7032FK

1/4" 25.000 RPM 4 VEL.



HYM AT-7033N



AT-7032LAN

1/4" 25.000 RPM 4 VEL.



RECTIFICADORES NEUMÁTICOS



HYM AT-7070C



HYM NST-7032LAM

1/4" 4 VEL.



EW-906
Kit de rectificador
con piedras



EW-906F
Kit de rectificador
con piedras

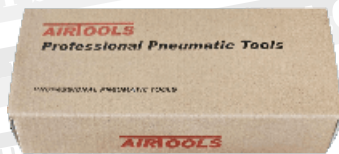

EW-702FL
Rectificador
neumático

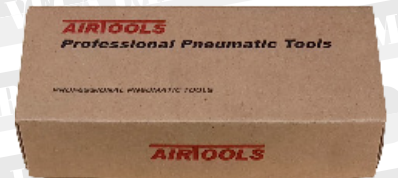

EW-702
Rectificador
neumático



RECTIFICADORES NEUMÁTICOS/ELÉCTRICOS



TP202K
Rectificador
neumático con
piedras
(Pequeño)



TP201K
Rectificador
neumático con
piedras

⊙ Rectificador Eléctrico



S1J-JQ-25

- Velocidad: 25 000 r/min
- Voltaje: 220V
- Frecuencia: 50 Hz
- Potencia: 230W

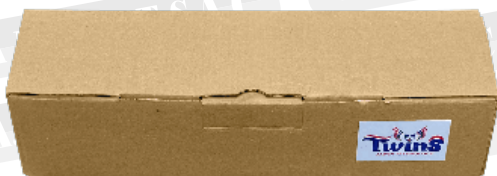

JSJ-F-25

- Velocidad: 25 000 r/min
- Diámetro de la piedra: 25 mm
- Voltaje: 220V
- Frecuencia: 50 Hz
- Potencia: 240W
- Cable: 1.8 m

CARB

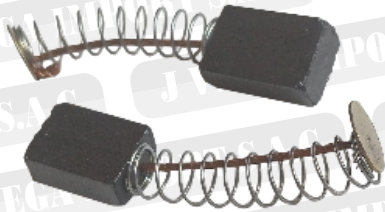

JSJ-F-01
Set de carbón
para rectificador
eléctrico



EW-JQ-01
Set de carbón
para rectificador
eléctrico

EW-JQ-02
Interruptor
para rectificador
eléctrico



Modo de uso



Herramientas

PIEDRAS PARA RECTIFICADOR

J VEGA IMPORT S.A.C



EB-046-23



EB-046-36



EB-043-23



42170



42183



42182



93-168



93-168A

Herramientas

PIEDRAS PARA RECTIFICADOR

J VEGA IMPORT S.A.C



HYM MST-002



SK-108



93-141



93140



ENVÍOS A TODO EL PERÚ

Ofrecemos amplia cobertura

Herramientas

MINICOMPRESORAS / PISTOLAS

J VEGA IMPORT S.A.C



HK-TC-518

12V

150PSI



HK-TC-308

12V

150PSI

🎯 Pistola para soplear



DG-115



K-601-K



DG-10-KA



ENVÍOS A TODO EL PERÚ

Ofrecemos amplia cobertura

Herramientas

PISTOLA PARA SOPLETEAR

J VEGA IMPORT S.A.C



AD-01K

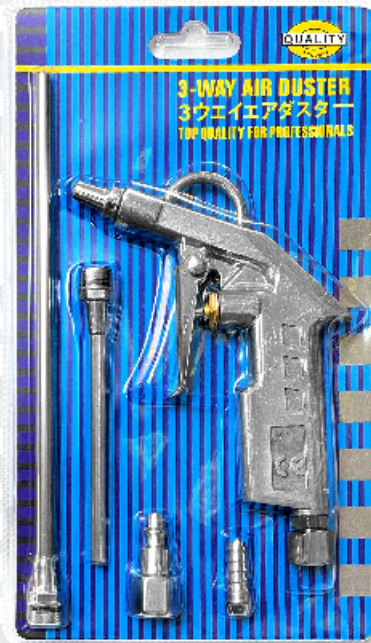

SD-103



DG-10-03



BS-04



ESPU1004



ENVÍOS A TODO EL PERÚ

Ofrecemos amplia cobertura

PISTOLA PARA PULVERIZAR

🎯 Pulverizadores



SD-104



DG-10-EK



SN-03

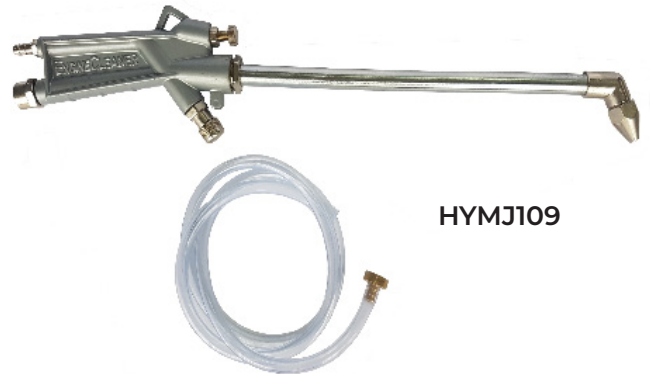

HYMJ109



PS-3



WG-01



ENVÍOS A TODO EL PERÚ

Ofrecemos amplia cobertura

Herramientas

PULVERIZADOR / PISTOLAS PARA LAVADO

J VEGA IMPORT S.A.C



HYM WG-01A



WG-02

🎯 Pistolas para lavado



WG-08



WG-10

Herramientas

PISTOLA PARA PINTAR

📍 Pistolas para pintar

J VEGA IMPORT S.A.C



472S



J-112



ENVÍOS A TODO EL PERÚ

Ofrecemos amplia cobertura

PISTOLAS DE IMPACTO NEUMÁTICA



MT-2822

1/2"

720 NM



MT-5200

3/4"

1350 NM



TZM-2811

1/2"

8000 RPM

550 NM

2.6 KG

- ▶ Diámetro del perno: 16 mm
- ▶ Presión del aire: 6.3 - 8 kg / cm²
- ▶ Dados: 24, 22, 19, 17, 15, 14, 13, 12 mm



TZM-4700

1/2"

7500 RPM

900 NM

2.8 KG

- ▶ Diámetro del perno: 18 mm
- ▶ Presión del aire: 6.3 - 8 kg / cm²
- ▶ Dados: 24, 22, 19, 17, 15, 14, 13, 12 mm

PISTOLAS DE IMPACTO NEUMÁTICA



TZM-3602

1/2" 7500 RPM 960 NM 3.1 KG

- ▶ Diámetro del perno: 18 mm
- ▶ Presión del aire: 6.3 - 8 kg / cm²
- ▶ Dados: 24, 22, 19, 17, 15, 14, 13, 12 mm



TZM-3702

1/2" 7500 RPM 960 NM 3.2 KG

- ▶ Diámetro del perno: 18 mm
- ▶ Presión del aire: 6.3 - 8 kg / cm²
- ▶ Dados: 24, 22, 19, 17, 15, 14, 13, 12 mm



TZM-4900A

1/2" 7500 RPM 1085 NM 3.2 KG

- ▶ Diámetro del perno: 18 mm
- ▶ Presión del aire: 6.3 - 8 kg / cm²
- ▶ Dados: 24, 22, 19, 17, 15, 14, 13, 12 mm



TZM-4100

1/2" 7500 RPM 1000 NM 3 KG

- ▶ Diámetro del perno: 18 mm
- ▶ Presión del aire: 6.3 - 8 kg / cm²
- ▶ Dados: 24, 22, 19, 17, 15, 14, 13, 12 mm

PISTOLAS DE IMPACTO NEUMÁTICA



TZM-3903

1/2" 8000 RPM 1000 NM

► Datos: 12, 13, 14, 15, 17, 19, 22 y 24 mm



TZM-5003

1/2" 6200 RPM 1300 NM

► Datos: 12, 13, 14, 15, 17, 19, 22, 24 mm



TZM-3906

1/2" 6500 RPM 1200 NM

► Datos: 12, 13, 14, 15, 17, 19, 22, 24 mm



TZM-2805

1/2" 10500 RPM 550 NM

► Presión del aire: 6.3 / 90 psi

PISTOLAS DE IMPACTO NEUMÁTICA



TZM-790

3/4" 4600 RPM 1800 NM 7 KG

- ▶ Diámetro del perno: 31 mm
- ▶ Presión del aire: 6.3 - 10 kg / cm²
- ▶ Dados: 27 y 32 mm



TZM-750

3/4" 6000 RPM 1600 NM 5.4 KG

- ▶ Diámetro del perno: 32 mm
- ▶ Presión del aire: 6.3 - 10 kg / cm²
- ▶ Dados: 27 y 32 mm



TZM-751

3/4" 5300 RPM 1700 NM 5.8 KG

- ▶ Diámetro del perno: 32 mm
- ▶ Presión del aire: 6.3 - 10 kg / cm²
- ▶ Dados: 27 y 32 mm



TZM-681A

3/4" 4800 RPM 1950 NM

- ▶ Dados: 32 y 33 mm

Herramientas

PISTOLAS DE IMPACTO NEUMÁTICA

J VEGA IMPORT S.A.C



TZM-A12

1"

3800 RPM

3500 NM

17 KG

- ▶ Diámetro del perno: 48 mm
- ▶ Presión del aire: 8 - 12 kg / cm²
- ▶ Dados: CRV 36 y 38 mm



TZM-5068

1"

3800 RPM

3500 NM

17 KG

- ▶ Diámetro del perno: 48 mm
- ▶ Presión del aire: 8 - 12 kg / cm²
- ▶ Dados: CRV 36 y 38 mm



ENVÍOS A TODO EL PERÚ

Ofrecemos amplia cobertura

PISTOLAS DE IMPACTO NEUMÁTICA



TZM-550A

1"

4200 RPM

2500 NM

14 KG

- ▶ Diámetro del perno: 41 mm
- ▶ Presión del aire: 8 - 12 kg / cm²
- ▶ Dados: CRV 33 y 32 mm



TZM-550B

1"

4200 RPM

2500 NM

14 KG

- ▶ Diámetro del perno: 41 mm
- ▶ Presión del aire: 8 - 12 kg / cm²
- ▶ Dados: CRV 38 y 41 mm



PISTOLAS DE IMPACTO NEUMÁTICA



TZM-A16

1"	3600 RPM	3600 NM	18.5 KG
----	----------	---------	---------

- ▶ Diámetro del perno: 50 mm
- ▶ Presión del aire: 8 - 14 kg / cm²
- ▶ Dados: CRV 38 y 41 mm

TZM-A8B

1"	4200 RPM	3000 NM	14 KG
----	----------	---------	-------

- ▶ Diámetro del perno: 41 mm
- ▶ Presión del aire: 8 - 12 kg / cm²
- ▶ Dados: CRV 38 y 41 mm



PISTOLAS DE IMPACTO NEUMÁTICA

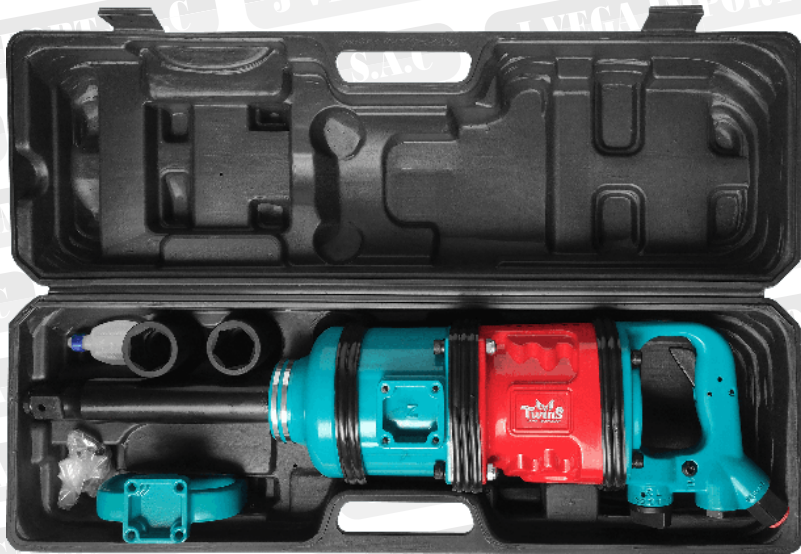

TZM-1790

1"	3300 RPM	3800 NM	18.7 KG
----	----------	---------	---------

- ▶ Diámetro del perno: 50 mm
- ▶ Presión del aire: 8 - 14 kg / cm²
- ▶ Dados: CRV 32 y 33 mm

TZM-1290

1"	3300 RPM	3800 NM
----	----------	---------

- ▶ Dados: 38 y 41 mm



PISTOLAS DE IMPACTO NEUMÁTICA



T2M-1295

1"

3200 RPM

4180 NM

► Dados:
36 y 41 mm



T2M-780

1"

4600 RPM

1600 NM

► Dados:
32 y 33 mm



T2M-681B

1"

4800 RPM

1950 NM

► Dados:
32 y 33 mm

PISTOLAS DE IMPACTO NEUMÁTICA



TZM-550A-1

1" 4200 RPM 2500 NM

► Dados: 32 y 33 mm

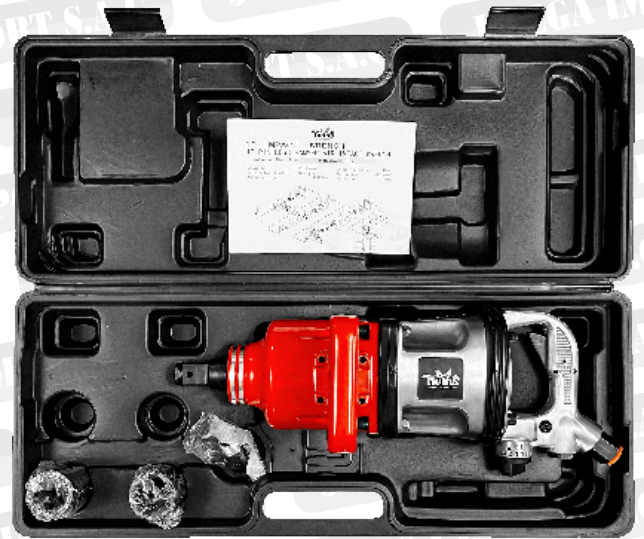

TZM-A12-1

1" 3800 RPM 3200 NM

► Dados: 32, 33 mm

TZM-2305

1" 3200 RPM 4500 NM

► Dados: 32 y 33 mm



Herramientas

PISTOLAS DE IMPACTO NEUMÁTICA

J VEGA IMPORT S.A.C



MT-550A

1"

2800 NM



MT-5068

1"

3200 NM

Soporte para pistola de impacto

EW-WH

Soporte para pistola de impacto de 1".



PIEZAS DE PISTOLA

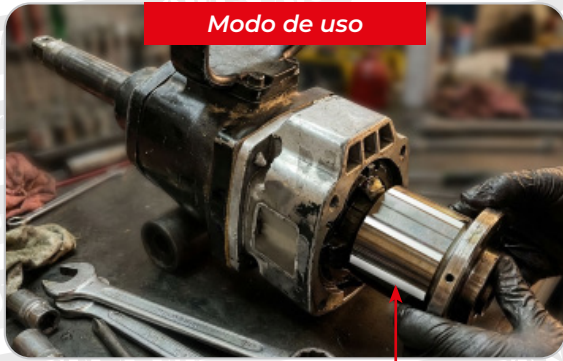

Modo de uso



CÓDIGO
TZM-550AC
TZM-A8BC
TZM-A12C
TZM-A16C
TZM-1290C
TZM-2305C



CÓDIGO
TZM-550A-G
TZM-A12-G
TZM-A16-G
TZM-1290-G
TZM-2305-G



CÓDIGO
TZM-A8B#9
TZM-A12#10
TZM-A16#10
TZM-550A#9
TZM-5068#10



TZM-A8B#9
Pico para pistola



AT-4500#14
Martillo para pistola
neumática liviana



AT-9981#14
Martillo para
pistola neumática



TP-013
Set de válvula y
resorte para pistola
neumática



TZM-VR
Set de válvula y
resorte para
pistola neumática



JZM-V
Set de válvula y
resorte para
pistola neumática

PISTOLA DE IMPACTO INALÁMBRICA



HK-PB400

Pistola de impacto inalámbrica con luz led

1/2" 2500 RPM 450 NM

- ▶ Tiempo de carga: 2 horas
- ▶ Incluye: 3 niveles de fuerza, 2 baterías de 20V / 4Ah



HK-PB400D

Pistola de impacto inalámbrica con luz led

1/2" 2500 RPM 450 NM

- ▶ Tiempo de carga: 2 horas
- ▶ Incluye: 3 niveles de fuerza, 2 baterías de 20V / 4Ah



HK-PB700

Pistola de impacto inalámbrica con luz led

1/2" 2500 RPM 880 NM

- ▶ Tiempo de carga: 2 horas
- ▶ Incluye: 3 niveles de fuerza, 2 baterías de 20V / 4Ah



HK-PB1300

Pistola de impacto inalámbrica con luz led

1/2" 2500 RPM 1800 NM

- ▶ Tiempo de carga: 2 horas
- ▶ Incluye: 4 niveles de fuerza, 2 baterías de 20V / 6Ah

PISTOLA ELÉCTRICA / INALÁMBRICA

HK-PB1600

Pistola de impacto inalámbrica con luz led

3/4"

1800 RPM

2000 NM

- ▶ Tiempo de carga: 2 horas
- ▶ Incluye: 4 niveles de fuerza, 2 baterías de 20V / 6Ah



HK-PB2500L

Pistola de impacto inalámbrica con pico largo y luz led

1"

1200 RPM

2700 NM

- ▶ Incluye: 4 niveles de fuerza, 2 baterías de 20V / 6Ah



HK-HT24

Pistola de impacto de 1" inalámbrica de 24V c/ luz led

- ▶ 4 niveles de torque: 800 Nm / 1000 Nm / 1300 Nm / 1500 Nm
- ▶ Dados: 32 y 33
- ▶ Tiempo de carga: 2 horas
- ▶ Voltaje de batería: 24V/6.0Ahx2

PISTOLA DE IMPACTO INALÁMBRICA



HTB-6

Batería para pistola de impacto inalámbrica

20V 6.0AH



CD2021

Pistola de impacto inalámbrica con luz led

3/4"

2800 RPM

1600 NM

► Incluye:
2 baterías de 21V / 4Ah



M18-2867-3000

Pistola de impacto inalámbrica con luz led

1"

3000 NM

► Incluye:
1 batería de 118V / 6.0Ah

PISTOLA ELÉCTRICA / INALÁMBRICA

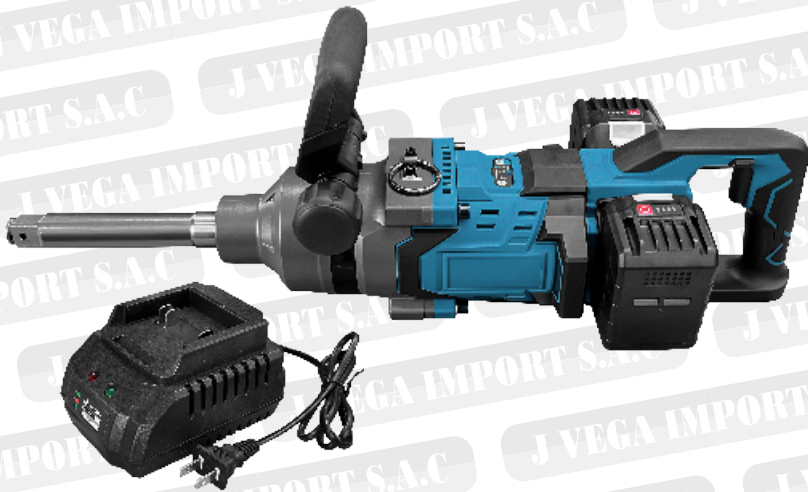

ETP-15

Pistola de impacto inalámbrica con luz led

1" 4000 NM

- ▶ Incluye:
2 baterías
4 niveles de fuerza

PB3000

Pistola de impacto inalámbrica con luz led

1" 4000 NM

- ▶ Incluye:
2 baterías
4 niveles de fuerza
- ▶ Velocidad: 1250/1450/1800 rpm
- ▶ Potencia: 500w



19 cm

⦿ Repuesto para pistola de impacto eléctrica



WRENCH PART-1



GSP-06



TP-419



GSP-08

Boquilla de engrase



GN-09

FILTROS PARA COMPRESORA



EC4010-02
Medida: 1/4"
1.0MPa / 145 PSI



EC4010-04
Medida: 1/2"
1.0MPa / 145 PSI



AC4010-04
Medida: 1/2"
1.0MPa / 145 PSI



BFR2000
Medida: 1/4"
150 PSI



AFR2500
Medida: 1/4"
1.0MPa / 145 PSI



397-8
Medida: 1/4"
1.0MPa / 145 PSI



HYM AF-2
Medida: 1/4"



SK-214
Medida: 1/4"

Empaquetadura para filtro

HYM ACC-4010
Empaquetadura para filtro
AC4010-04



ENVÍOS A TODO EL PERÚ

Ofrecemos amplia cobertura

DADOS DE IMPACTO

J10007

Set de dados de impacto de 1/2" de 4 piezas (17/19/21/22)



J10008

Set de dados de impacto de 1/2" de 4 piezas (17/19/21/22)



J10019

Set de dados de impacto de 1/2" de 13 piezas (10/12/13/14/15/17/19/21/22/24/27/30/32)



J10037

Set de dados de impacto de 1" (90 mm) de 5 pzs (21/32/33/38/41)



J10030

Set de dados de impacto de 3/4" (90 mm) de 10 pzs (19/21/24/27/30/32/33/36/38/41)



J10041

Set de dados de impacto de 1" (90 mm) de 10 pzs (17/21/24/27/30/32/33/35/38/41)



J10042

Set de dados de impacto de 1" (80 mm) de 12 pzs (21/24/25/27/28/30/32/33/35/36/38/41)

DADOS DE IMPACTO



HK-SOCKET-10
Set de dados encaste de 1"
(17; 21; 24; 27; 30; 32; 33; 35; 38; 41)



17MM-1/2 17mm Latón
19MM-1/2 19mm Latón
21MM-1/2 21mm Latón
22MM-1/2 22mm Latón



SOCKET-13
Set de dados encaste de 1/2"
(10, 11, 12, 13, 15, 17, 19, 21, 22, 24, 27, 32 mm)



SOCKET-1210
Set de dados encaste de 1/2"
(10, 11, 12, 13, 15, 17, 19, 21, 22, 24 mm)



HYM ASK-001
Set de dados de impacto 1/2"
(9; 10; 11; 13; 14; 17; 19; 22; 24; 27)





TZM-41MM
Dados Twins de encaste de 1"
(21; 32; 33; 38; 41)
8 cm de Largo



17 mm

DADO CHUPON VANADIUM

Encaste de 1"
(17; 19; 21; 22)



19 mm



17 mm

DADOS HEXAGONAL VANADIUM

Encaste de 1"
(17; 19; 21; 22; 24; 27; 28; 30; 32; 33; 35; 36; 38; 41)



21 mm



17 mm

DADO CHUPON DE CROMO

Encaste de 1"
(17; 19; 21; 22)



19 mm



19 mm

DADO HEXAGONAL DE CROMO

Encaste de 1"
(17; 19; 21; 22; 24; 27; 28; 30; 32; 33; 35; 36; 38; 41)



22 mm



ENVÍOS A TODO EL PERÚ

Ofrecemos amplia cobertura

DADOS DE IMPACTO DE CROMO



DADO CHUPON DE 21 mm
Encaste de 1"
SOCKET21

DADO CHUPON DE 22 mm
Encaste de 1"
SOCKET22



DADO HEXAGONAL DE 32 mm
Encaste de 1"
SOCKET32

CÓDIGO	MEDIDA
SOCKET27	27 mm
SOCKET30	30 mm
SOCKET32	32 mm
SOCKET33	33 mm
SOCKET35	35 mm
SOCKET36	36 mm
SOCKET41	41 mm



ENVÍOS A TODO EL PERÚ

Ofrecemos amplia cobertura

Herramientas

SILICONA / LIMPIADORES

J VEGA IMPORT S.A.C

● Silicona



99939

Silicona para unir
piezas de motor



● Limpiadores



21341102 (400ml)

Para limpieza previa al área
de reparación y colocación
del parche.

21341202 (400ml)

Para limpiar el aro antes de
pegar los plomos adhesivos



ENVÍOS A TODO EL PERÚ

Ofrecemos amplia cobertura

⊙ Aceites para herramientas



21320104 (750 ml)
Aceite para herramientas
neumáticas



32180010 (950 ml)
Aceite para compresora



32180030 (950 ml)
Aceite para gatas
hidráulicas

⊙ Aceites para moto

JVX10W30

Aceite para
motocicleta

4T 10W30

API SL

Semi Sintético



JVX20W50

Aceite para
motocicleta

4T 20W50

API SL

Mineral



ENVÍOS A TODO EL PERÚ

Ofrecemos amplia cobertura

ABRIDOR DE LLANTAS

Oring para maquinaria



OR325TA-9.8



OR325T-9.8



EW-OR325T



15446
Myers



15828
Myers



15831
Myers

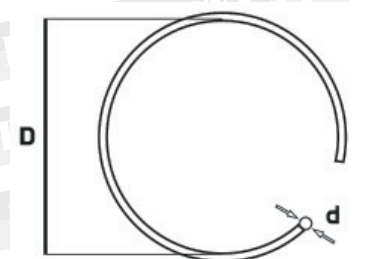
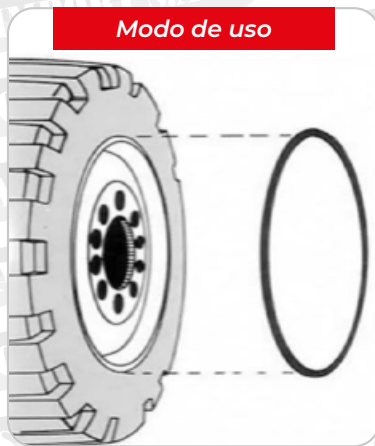

	Ø AROS	D	d	MEDIDA DE NEUMÁTICOS
OR-224	610	559	6.6	9.00.24 / 10.00.24 12.00.24 / 13.00.24 14.00.24 / 16.00.24
OR-225	635	581	6.6	12.00.25 / 13.00.25 14.00.25 / 15.5.25 17.5.25 / 7.50.25 9.00.25
OR-325	635	573	9.5	16.00.25 / 18.00.25 20.5.25 / 21.00.25 24.00.25 / 26.5.25 29.5.25



SSK-122
Abridor de llanta con
bandeja y luz led
Aro compatible:
13" - 17.5"

SSK-120
Abridor neumático
para llanta con luz led,
pedales y bandeja



Aro compatible:
13" - 17.5"



GL-222
Abridor de llanta manual
Aro compatible: 13" - 20"

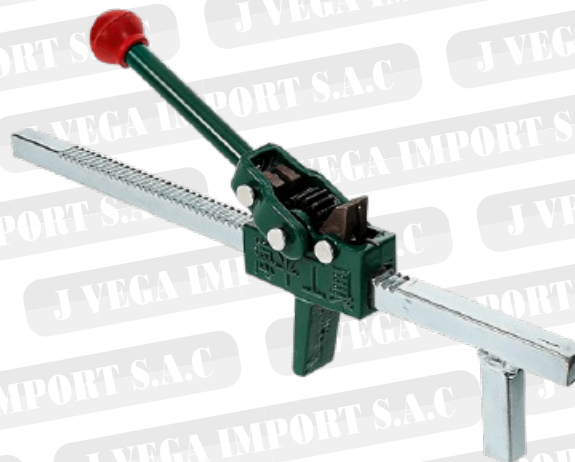

HP-018
Abridor de llanta manual
Aro compatible: 13" - 20"



SH-31

Abridor de llanta para camión
Compatibilidad de aro: 15" - 24.5"

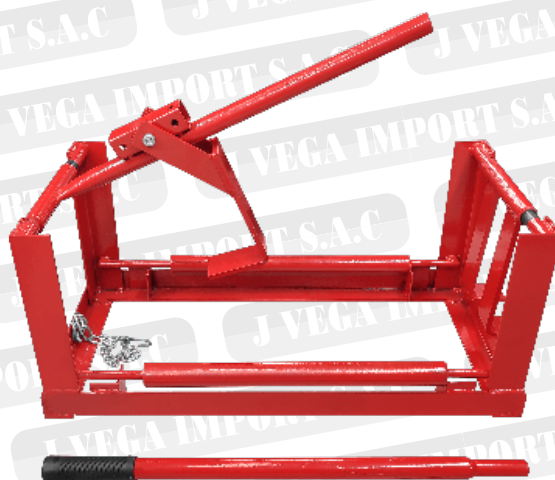

JSH-31

Abridor de llanta para camión
Compatibilidad de aro: 15" - 24.5"



TC-002

Abridor de llanta para camión
Compatibilidad de aro: 15" - 24.5"



ENVÍOS A TODO EL PERÚ

Ofrecemos amplia cobertura



MAPREN-G



HD-1

- ▶ Voltaje: 220V-240V
- ▶ Fuerza: 500w
- ▶ Temperatura: 145-165 °C
- ▶ Área de trabajo: 60x60mm²



VI-VULC01

Vulcanizadora para cámara 220V



VI-VULS02

Vulcanizadora Super 220V



VI-VULA03

Vulcanizadora de neumáticos para auto



VI-VULC04

Vulcanizadora de neumáticos para camión



Luz de encendido



SJD-4

Máquina vulcanizadora para neumáticos

- ▶ Voltaje: 220V
- ▶ Fuerza: 500w x 2
- ▶ Temperatura: 145-165 °C
- ▶ Accesorios: 6 Planchas



SJD-D

Vulcanizadora para neumático de auto

- ▶ Voltaje: 220V
- ▶ Fuerza: 500w x 2
- ▶ Temperatura: 145-165 °C
- ▶ Accesorios: 6 Planchas

SJD-1

Vulcanizadora con temporizador

- ▶ Voltaje: 220V
- ▶ Fuerza: 500w
- ▶ Temperatura: 145-165 °C
- ▶ Área de trabajo: 80x80 mm²



6 Planchas



PLANA



TIJERA



ANGOSTA



ANCHA

Planchas



MA001

Plancha plana pulida



MA002

Plancha ovalada pulida

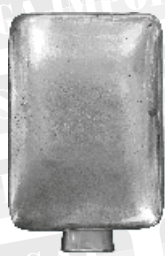

MA003

Plancha pitonera pulida

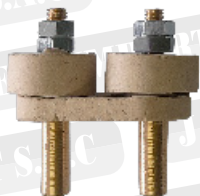
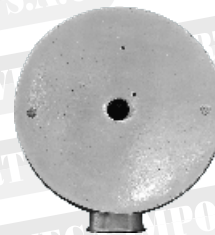

ESP01

ESPIGA



CORD

Enchufe para plancha



LOZA

LOZA PARA PLANCHA



ENVÍOS A TODO EL PERÚ

Ofrecemos amplia cobertura

MULTIPLICADOR DE FUERZA



HK-TC-18

1/2" Encastre 17,19,21 Dados

Para auto, combi y camioneta



HK-TC-78A

1" Encastre 7800 NM Capacidad 32, 33 Dados



HK-TC-68C

1" Encastre 6800 NM Capacidad 32, 33 Dados



HK-TC-3200

1" Encastre 5800 NM Capacidad 32, 33 Dados



LLAVE CRUZ / LLAVE DE RUEDA



EW-011
(Plegable)



TRX31101-14"
Llave de rueda de 14"



TRX31101-16"
Llave de rueda de 16"



EW-002-14C
Llave de rueda de 14"

MEDIDAS 17 / 19 / 21 / 22



EW-002-18C
Llave de rueda de 18"

MEDIDAS 17 / 19 / 21 / 22



EW-002-20C
Llave de rueda de 20"

MEDIDAS 17 / 19 / 21 / 22



EW-002-14P
Llave de rueda de 14"

MEDIDAS 17 / 19 / 21 / 22



EW-002-18P
Llave de rueda de 18"

MEDIDAS 17 / 19 / 21 / 22



EW-002-20P
Llave de rueda de 20"

MEDIDAS 17 / 19 / 21 / 22



ENVÍOS A TODO EL PERÚ

Ofrecemos amplia cobertura

LLAVE CRUZ / LLAVE DE RUEDA

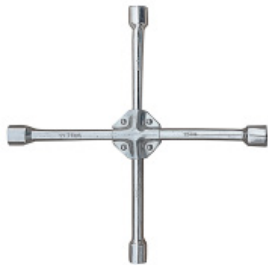

EW-004-14P

Llave de rueda de 14"(Reforzada)

MEDIDAS

17 / 19 / 21 / 22



EW-004-18P

Llave de rueda de 18"(Reforzada)

MEDIDAS

17 / 19 / 21 / 22



SD-018-14"

Llave cruz plegable de 14"

MEDIDAS

17 / 19 / 21 / 23

⊙ Llave de cruz

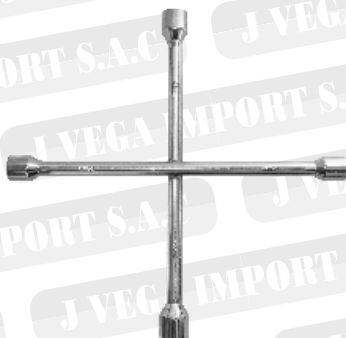

TW-01-14"

Llave cruz de 14" pulida
17 / 19 / 21 / 22



TW-01-20"

Llave cruz de 20" pulida
17 / 19 / 21 / 22

TRAMONTINA



32X33 mm

42811/001 (50 cm)



MEDIDA

24x27 mm

27x30 mm

27x32 mm

27x33 mm

MEDIDA

21x41 mm

32x33 mm

35x17mm

38x21 mm

LLAVE DE RUEDA / DESTALONADORA



EW-005-32
Llave de rueda 30 X 32



EW-005-30
Llave de rueda 27 X 30



EW-005-41
Llave de rueda 21 X 41



TRX83375
Llave de rueda "L"
Dados: 19 y 23 mm



EW-012
Llave de rueda "L"
Dados: 17 y 23 mm

Destalonadora OTR



TB-01
▶ Capacidad: 10,000 PSI
▶ PSI de trabajo: 80 PSI
▶ Medidas de aro: 21" - 51"



TB-02
▶ Capacidad: 10,000 PSI
▶ PSI de trabajo: 80 PSI
▶ Medidas de aro: 21" - 51"

Herramientas
DESTALONADORA

J VEGA IMPORT S.A.C



G15

- ▶ Peso total: 12,6 kg
- ▶ Presión de aire: 0,63 MPa
- ▶ Longitud: 75.5 cm



G15-1

- ▶ Peso total: 11.9 kg
- ▶ Presión de aire: 0,63 MPa
- ▶ Longitud: 74.4 cm



JT-G15



G10



Modo de uso



GL15-01

Repuesto para destalonadora



GL-TS1

Destalonadora para neumáticos con dado

- ▶ Dado: 32 mm
- ▶ Rango de rines: 14" - 42"

Herramientas
DESTALONADORA

J VEGA IMPORT S.A.C



EHG-038D
Destalonadora manual naranja



EHG-038A
Destalonadora manual amarilla



🔴 Mazo para desmontar llantas



T11EH-51



T11EH-52



T11EH-53



DCT80(12)
Palanca plana de 12" (30 cm)



DCT80(16)
Palanca plana de 16" (40 cm)



DCT80(24)
Palanca plana de 24" (60 cm)



DCT80(28)
Palanca plana de 28" (70 cm)



TL-3
Palanca 18"x19 mm

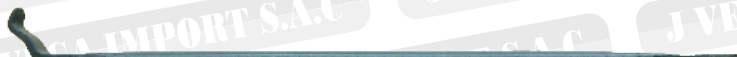

TL-8
Palanca 24"x19 mm

TL9
Palanca 30"x19 mm



Herramientas

PALANCA DESMONTADORA

J VEGA IMPORT S.A.C



TL-01A
Palanca plana de 12"



TL-02A
Palanca plana de 16"



TL-03A
Palanca plana de 18"



TL-04A
Palanca plana de 20"



TL-05A
Palanca plana de 25"



TL-06A
Palanca plana de 28"



TL-07A
Palanca plana de 32"



ENVÍOS A TODO EL PERÚ

Ofrecemos amplia cobertura

Herramientas

PALANCA DESMONTADORA

J VEGA IMPORT S.A.C



16801



16802



16803



16804



16805



16806



ENVÍOS A TODO EL PERÚ

Ofrecemos amplia cobertura

PALANCA SACA PESTAÑA



STR-65



EHG-12325



📍 Palanca desmontadora



STR35

STR-64
Set de palanca de 2 piezas



EHG-038C
Set de palanca de 3 piezas



EHG-038B
Set de palanca de 2 piezas c/seguro



EHG-038CA
Set de palanca de 3 piezas





EHG-16803



TL-7-37"A



TL-295MM

A
R
M
A
D
O



TL-002



ENVÍOS A TODO EL PERÚ

Ofrecemos amplia cobertura

SET DE PALANCAS TNT



EHG-12320
Set de palanca TNT
Aro de 17.5" a 22.5"

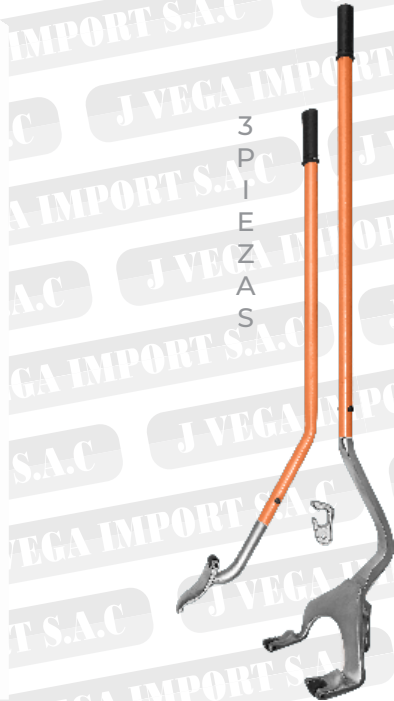

EHG-12320P
Palanca TNT pulida
Aro de 17.5" a 22.5"

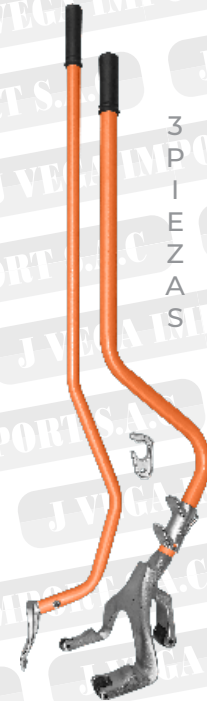

EHG-12321
Set de palanca TNT
Aro de 17.5" a 22.5"

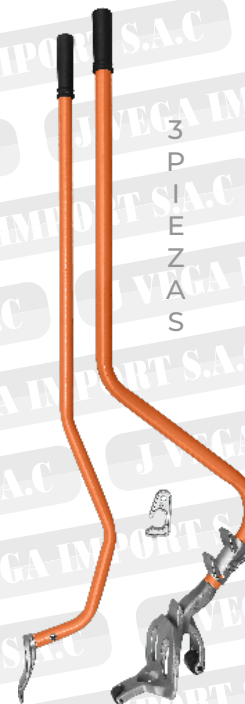

EHG-12328
Set de palanca TNT
Aro de 17.5" a 22.5"



STR-61/2
Set de palanca TNT
Aro de 17.5" a 22.5"



EHG-12327
Set de palanca TNT
Aro de 17.5" a 22.5"

GATA BOTELLA HIDRÁULICA



GATA HIDRAULICA BOTELLA (CJ X 6)

CÓDIGO	T90204D
CAPACIDAD	2 TN
ALTURA MIN.	148 mm
ALTURA MAX.	276 mm



GATA HIDRAULICA BOTELLA (CJ X 6)

CÓDIGO	T90204DS
CAPACIDAD	2 TN
ALTURA MIN.	148 mm
ALTURA MAX.	276 mm



GATA HIDRAULICA BOTELLA (CJ X 6)

CÓDIGO	T90404D
CAPACIDAD	4 TN
ALTURA MIN.	168 mm
ALTURA MAX.	326 mm



CÓDIGO	T90404DS
CAPACIDAD	4 TN
ALTURA MIN.	180 mm
ALTURA MAX.	350 mm

GATA BOTELLA HIDRÁULICA



GATA HIDRAULICA BOTELLA (CJ X 6)

CÓDIGO	T90604D
CAPACIDAD	6 TN
ALTURA MIN.	185 mm
ALTURA MAX.	355 mm



GATA HIDRAULICA BOTELLA (CJ X 4)

CÓDIGO	T90804D
CAPACIDAD	8 TN
ALTURA MIN.	190 mm
ALTURA MAX.	365 mm



GATA HIDRAULICA BOTELLA (CJ X 4)

CÓDIGO	T91004D
CAPACIDAD	10 TN
ALTURA MIN.	195 mm
ALTURA MAX.	375 mm



GATA HIDRAULICA BOTELLA (CJ X 3)

CÓDIGO	T91204D
CAPACIDAD	12 TN
ALTURA MIN.	200 mm
ALTURA MAX.	380 mm

GATA BOTELLA HIDRÁULICA



CÓDIGO	T91604D
CAPACIDAD	16 TN
ALTURA MIN.	205 mm
ALTURA MAX.	390 mm

GATA HIDRAULICA BOTELLA (CJ X 2)



GATA HIDRAULICA BOTELLA (CJ X 2)

CÓDIGO	T92004
CAPACIDAD	20 TN
ALTURA MIN.	242 mm
ALTURA MAX.	452 mm



GATA HIDRAULICA BOTELLA (CJ X 2)

CÓDIGO	T92004D
CAPACIDAD	20 TN
ALTURA MIN.	217 mm
ALTURA MAX.	407 mm

GATA BOTELLA HIDRÁULICA



GATA HIDRAULICA BOTELLA (CJ X 2)

GATA HIDRAULICA BOTELLA (CJ X 2)

CÓDIGO	T92007A-B
CAPACIDAD	20 TN
ALTURA MIN.	168 mm
ALTURA MAX.	277 mm

CÓDIGO	T92007A
CAPACIDAD	20 TN
ALTURA MIN.	168 mm
ALTURA MAX.	277 mm



Cód.: TH810002

Gata botella perfil - Doble pistón

CAPACIDAD	10 TN
ALTURA MIN.	128 mm
ALTURA MAX.	223 mm
PESO	7.7 kg



Cód.: TH820002

Gata botella perfil - Doble pistón

CAPACIDAD	20 TN
ALTURA MIN.	150 mm
ALTURA MAX.	245 mm
PESO	11.2 kg

GATA BOTELLA HIDRÁULICA



Cód.: TH93001

Gata botella con gusano (caja x 3)

- Capacidad: 30 Ton
- Alt. Mínima: 244 mm
- Alt. Máxima: 510 mm



Cód.: T932011

Gata hidráulica tipo botella (caja x 3)

- Capacidad: 32 Ton
- Alt. Mínima: 230 mm
- Alt. Máxima: 360 mm



Cód.: T950011

Gata hidráulica tipo botella

- Capacidad: 50 Ton
- Alt. Mínima: 240 mm
- Alt. Máxima: 370 mm



Cód.: J20105LP-10T

Gata hidráulica tipo botella con gusano

- Capacidad: 10 Ton



Cód.: J20108LP-20T

Gata hidráulica tipo botella con gusano

- Capacidad: 20 Ton
- Alt. Mínima: 200 mm
- Alt. Máxima: 385 mm



Cód.: J20109LP-32T

Gata hidráulica tipo botella con gusano

- Capacidad: 32 Ton
- Alt. Mínima: 225 mm
- Alt. Máxima: 403 mm



Cód.: J20101

- Capacidad: 2 Ton
- Alt. Mínima: 145 mm
- Alt. Máxima: 277 mm



Cód.: J20102

- Capacidad: 4 Ton
- Alt. Mínima: 179 mm
- Alt. Máxima: 374 mm



Cód.: J20103

- Capacidad: 6 Ton
- Alt. Mínima: 185 mm
- Alt. Máxima: 360 mm



Cód.: J20104

- Capacidad: 8 Ton
- Alt. Mínima: 200 mm
- Alt. Máxima: 395 mm



Cód.: J20105

- Capacidad: 10 Ton
- Alt. Mínima: 200 mm
- Alt. Máxima: 385 mm



Cód.: J20106

- Capacidad: 12 Ton
- Alt. Mínima: 210 mm
- Alt. Máxima: 405 mm



Cód.: J20107

- Capacidad: 16 Ton
- Alt. Mínima: 225 mm
- Alt. Máxima: 380 mm



Cód.: J20108

- Capacidad: 20 Ton
- Alt. Mínima: 235 mm
- Alt. Máxima: 455 mm



Cód.: J20109

- Capacidad: 32 Ton
- Alt. Mínima: 255 mm
- Alt. Máxima: 422 mm

GATA BOTELLA NEUMÁTICA

Cód.: HPJ1320

- Capacidad: 20 Ton
- Alt. Mín.: 505 mm
- Alt. Máx.: 262 mm
- Presión de aire: 0.75-0.85MPa



Cód.: MR8004-2

- Gata neumática perfil bajo
- Capacidad: 20 Ton
- Alt. Mín.: 210 mm
- Alt. Máx.: 390 mm
- Cap. Máx.: 44000 LBS
- Peso: 13 kg



Cód.: HPJ1330

- Capacidad: 30 Ton
- Cap. Máx.: 70560 LBS



Cód.: HPJ1335

- Capacidad: 35 Ton
- Cap. Máx.: 77100 LBS



Cód.: TQ20002

- Gata hidroneumática
- Capacidad: 20 Ton
- Alt. Mín.: 267 mm
- Alt. Máx.: 515 mm



Cód.: TRQ30002

- Gata hidroneumática
- Capacidad: 30 Ton
- Alt. Mín.: 255 mm
- Alt. Máx.: 405 mm



Cód.: TRQ35002

- Gata hidroneumática
- Capacidad: 35 Ton
- Alt. Mín.: 250 mm
- Alt. Máx.: 405 mm



Cód.: T43001C

Soporte o Caballete de 3 ton

- Capacidad: 3 ton
- Altura Mínima: 276 mm
- Altura Máxima: 420 mm



Cód.: T44005Q

Soporte o Caballete de 4 ton
(Incluye 01 soporte)

- Cap.: 4 ton
- Altura Mínima: 340 mm
- Altura Máxima: 505 mm
- Peso: 5.4 kg



Cód.: T43004

Soporte plegable de 3 ton

- Capacidad: 3 ton
- Altura Mínima: 286 mm
- Altura Máxima: 401 mm



Cód.: T46001C

Soporte o Caballete de 6 ton

- Capacidad: 6 ton
- Altura Mínima: 382 mm
- Altura Máxima: 600 mm



SET DE SOPORTE TWINS 3 TON

CÓDIGO	J20234
CAPACIDAD	3 TON
ALTURA MÍN.	11-1/2"
ALTURA MAX.	16-3/4"



SET DE SOPORTE TWINS 6 TON

CÓDIGO	J20235
CAPACIDAD	6 TON
ALTURA MÍN.	15-3/8"
ALTURA MAX.	23-1/4"

📍 Gatas Castillo



Cód.: J20215

→ Capacidad: 2 Ton

Cód.: T10202-GS

- Capacidad: 2 Ton
- Altura Mínima: 260 mm
- Altura Máxima: 390 mm
- Peso: 3.5 kg



GATA LAGARTO HIDRÁULICA



GATA LAGARTO DE 5.6 KGS EN CAJA DE CARTON

CÓDIGO	TA820011
CAPACIDAD	2 TN
ALTURA MIN.	140 mm
ALTURA MAX.	285 mm



Cód.: TA820011S-B

Gata Lagarto azul de 5.6 kg en caja de plástico

- ▶ Cap.: 2 Ton
- ▶ Alt. Mín.: 140 mm
- ▶ Alt. Máx.: 285 mm

Cód.: TA820011S

Gata Lagarto de 5.6 kg en caja de plástico

- ▶ Cap.: 2 Ton
- ▶ Alt. Mín.: 140 mm
- ▶ Alt. Máx.: 285 mm



ENVÍOS A TODO EL PERÚ

Ofrecemos amplia cobertura

GATA LAGARTO HIDRÁULICA



TA LAGARTO DE 6.8 KGS EN CAJA DE CARTON

CÓDIGO	TA82008
CAPACIDAD	2 TN
ALTURA MIN.	130 mm
ALTURA MAX.	300 mm



GATA LAGARTO DE 7.3 KGS EN CAJA DE CARTON

CÓDIGO	TA820014
CAPACIDAD	2 TN
ALTURA MIN.	135 mm
ALTURA MAX.	330 mm



TA LAGARTO C/MANGO GIRATORIO 360° DE 8.3 KGS



CÓDIGO	T820050R
CAPACIDAD	2 TN
ALTURA MIN.	135 mm
ALTURA MAX.	340 mm

GATA LAGARTO HIDRÁULICA



GATA LAGARTO DE 11.8 KGS

CÓDIGO	T825051
CAPACIDAD	2.5 TN
ALTURA MIN.	85 mm
ALTURA MAX.	380 mm



Mango giratorio 360°

GATA LAGARTO C/MANGO GIRATORIO 360° DE 14.2 KGS

CÓDIGO	T825010R
CAPACIDAD	2.5 TN
ALTURA MIN.	89 mm
ALTURA MAX.	359 mm

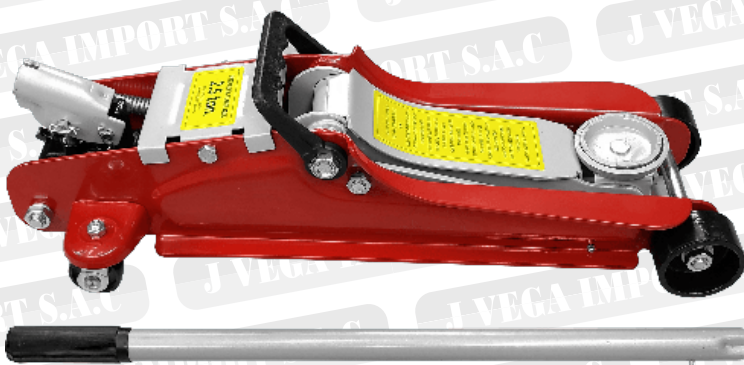

Cód.: J20205

Gata lagarto de 2.5 ton

- Capacidad: 2.5 Ton
- Altura Mínima: 85 mm
- Altura Máxima: 380 mm
- Peso: 12.5 kg



ENVÍOS A TODO EL PERÚ

Ofrecemos amplia cobertura

GATA LAGARTO HIDRÁULICA



GATA LIVIANA TIPO LAGARTO DE 2 TON EN CAJA

CÓDIGO	J20201
CAPACIDAD	2 Ton
ALTURA MÍN.	140 mm
ALTURA MÁX.	295 mm



GATA LIVIANA TIPO LAGARTO DE 2 TON CON MALETA DE PLÁSTICO

CÓDIGO	J20201P
CAPACIDAD	2 Ton
ALTURA MÍN.	140 mm
ALTURA MÁX.	295 mm



GATA PESADA TIPO LAGARTO DE 2 TON EN CAJA

CÓDIGO	J20204
CAPACIDAD	2 Ton
ALTURA MÍN.	135 mm
ALTURA MÁX.	315 mm



GATA PESADA TIPO LAGARTO DE 2 TON CON MALETA DE PLÁSTICO

CÓDIGO	J20204P
CAPACIDAD	2 Ton
ALTURA MÍN.	135 mm
ALTURA MÁX.	315 mm

Cód.: J20202

Gata lagarto livianade 3 ton

- Capacidad: 3 Ton
- Altura Mínima: 135 mm
- Altura Máxima: 460 mm
- Peso: 22 kg

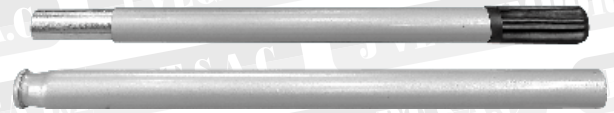
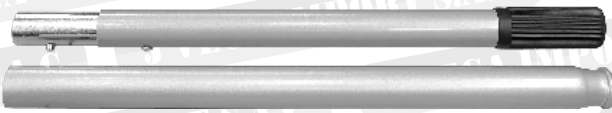

Cód.: J20203H

Gata lagarto de 3 ton

- Capacidad: 3 Ton
- Altura Mínima: 140 mm
- Altura Máxima: 520 mm
- Peso: 33 kg

Cód.: J20203

Gata lagarto pesada 3 ton

- Capacidad: 3 Ton
- Altura Mínima: 135 mm
- Altura Máxima: 495 mm
- Peso: 29 kg

Cód.: J20209

Gata lagarto de 5 ton perfil bajo doble bombín

- Capacidad: 5 Ton
- Altura Mínima: 105 mm
- Altura Máxima: 520 mm
- Peso: 43 kg

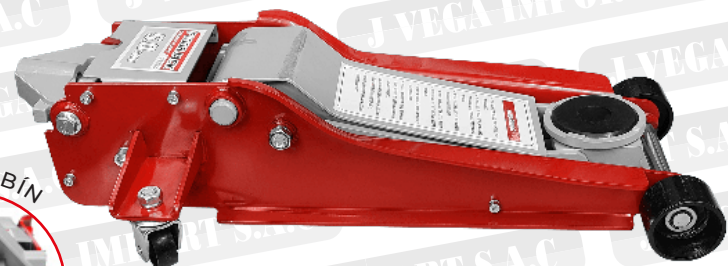
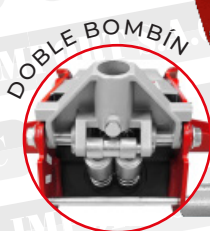

GATA LAGARTO HIDRÁULICA



Mango giratorio 360°

CÓDIGO	T83003C
CAPACIDAD	3 TN
ALTURA MIN.	130 mm
ALTURA MAX.	410 mm



GATA LAGARTO LIVIANA C/MANGO GIRATORIO 360°

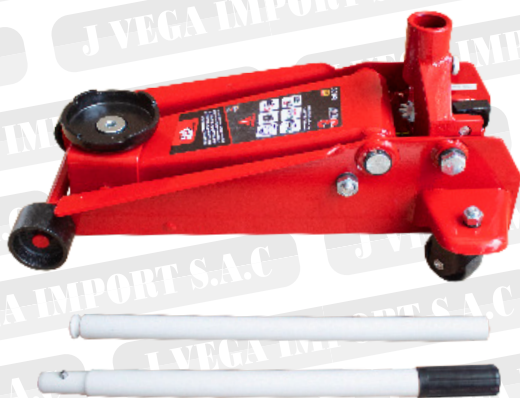

Cód.: T830025

GATA LAGARTO LIVIANA DE 28.2 KG

- Capacidad: 3 Ton
- Altura Mínima: 130 mm
- Altura Máxima: 465 mm



Cód.: T830022

GATA LAGARTO PESADA 36.6 KG

- Capacidad: 3 Ton
- Altura Mínima: 140 mm
- Altura Máxima: 520 mm



ENVÍOS A TODO EL PERÚ

Ofrecemos amplia cobertura

GATA LAGARTO HIDRÁULICA

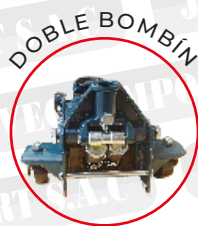

GATA LAGARTO C/DOBLE BOMBÍN 29.3 KGS

CÓDIGO	T830023
CAPACIDAD	3 TN
ALTURA MIN.	130 mm
ALTURA MAX.	465 mm

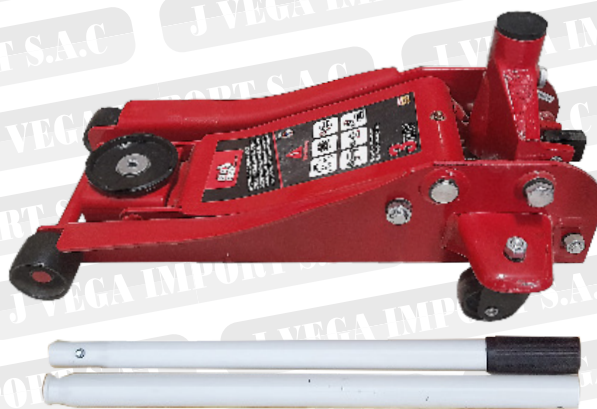

CÓDIGO	T830018
CAPACIDAD	3 TN
ALTURA MIN.	87 mm
ALTURA MAX.	455 mm

GATA LAGARTO C/PERFIL BAJO 34.4 KGS

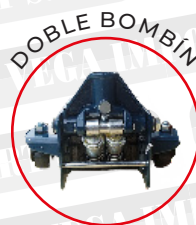

**GATA LAGARTO C/DOBLE BOMBÍN
PERFIL BAJO DE 33.4 KGS**

CÓDIGO	TZ830026X
CAPACIDAD	3 TN
ALTURA MIN.	80 mm
ALTURA MAX.	508 mm

GATA LAGARTO HIDRÁULICA



CÓDIGO	TZH830026X
CAPACIDAD	3 TN
ALTURA MIN.	78.7 mm
ALTURA MAX.	508 mm

GATA LAGARTO C/DOBLE BOMBIN DE PERFIL BAJO



CÓDIGO	T83502
CAPACIDAD	3.5 TN
ALTURA MIN.	145 mm
ALTURA MAX.	500 mm



GATA LAGARTO C/PEDAL DE LEVANTAMIENTO RAPIDO DE 38.4 KGS



CÓDIGO	TZ830009
CAPACIDAD	3 TN

GATA LAGARTO C/DOBLE BOMBIN DE PERFIL BAJO

GATA LAGARTO HIDRÁULICA



CÓDIGO	TZ83508V
CAPACIDAD	3.5 TN
ALTURA MIN.	100 mm
ALTURA MAX.	535 mm

GATA LAGARTO DE PERFIL BAJO



CÓDIGO	T84007
CAPACIDAD	4 TN
ALTURA MIN.	98 mm
ALTURA MAX.	508 mm



GATA LAGARTO C/DOBLE BOMBIN
PERFIL BAJO 43.1 KGS



GATA PESADA DE DOBLE
BOMBÍN DE 3 TON

CÓDIGO	J20203DH
CAPACIDAD	3 TN
ALTURA MÍN.	125 mm
ALTURA MÁX.	480 mm

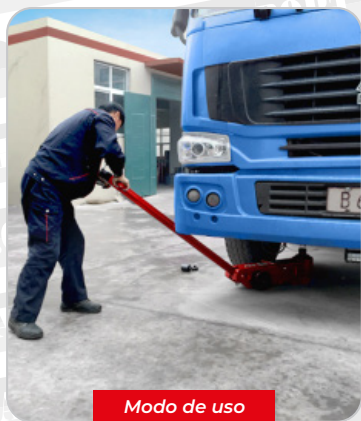

PJ-50/25

Gata hidroneumática para vehículos pesados

- ▶ Capacidad máxima: 50 Ton
- ▶ Ancho del cuerpo superior: 145 mm
- ▶ Peso de gata: 45 kg
- ▶ Altura mínima: 165 mm



PJ-80/40

Gata hidroneumática para vehículos pesados

- ▶ Capacidad máxima: 80 Ton
- ▶ Ancho del cuerpo superior: 168 mm
- ▶ Peso de gata: 62 kg
- ▶ Altura mínima: 205 mm



G-132-5T

Gata neumática de 5 ton

- ▶ Presión: 8 kg / cm²
- ▶ Carga máxima: 5 ton
- ▶ Alt. mín.: 15 cm
- ▶ Alt. máx: 40 cm



G-131-3T

Gata neumática de 3 ton

- ▶ Presión: 8 kg / cm²
- ▶ Carga máxima: 3 ton
- ▶ Alt. mín.: 15 cm
- ▶ Alt. máx: 40 cm

REPUESTOS DE GATA



HPJ13-1

Bomba neumática para gata



TRQ3-1

Bomba neumática para gata



TLR38

Resorte para gata lagarto



T28

Tapón de aceite para gatas lagarto

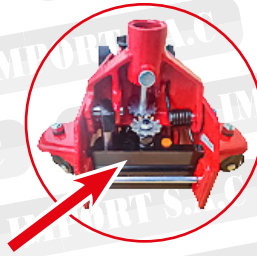

T5

Tapón de aceite para gata tipo botella

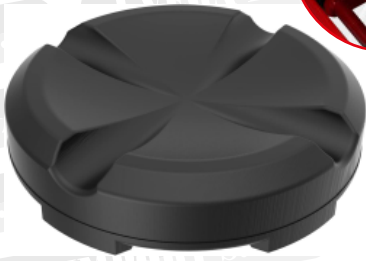

T83502-5

Soporte de jebe para base de gata lagarto



TLD24

Rueda delantera para gata lagarto de 2 ton



TLD15

Rueda delantera para gata lagarto de 3 ton



JTDW3-1

Set de 2 ruedas para gata lagarto de 3 ton



JTDW3

Set de 2 ruedas para gata lagarto de 3 ton



JTDW2

Set de 2 ruedas para gata lagarto de 2 ton



T830023-8

Soporte de jebe para gata lagarto

Modelos compatibles:
T830023, T830025



T830021-3

Soporte de jebe para gata lagarto

Modelos compatibles:
T830021, T83002, T825021,
T830021Q



T830021-4

Rueda para gata lagarto de 3 TON TORIN

Modelos compatibles:
T83502 series, T830021 series, T83000F, T830022, T830021Q, T830021B, T8300E



T830023B-1

Rueda para gata lagarto de 3 TON TORIN

Modelos compatibles:
T83508 series, T830025 series, T830018Z series, T84008, T84007, T830023 series



T820010BL-3

Rueda para gata lagarto de 3 TON TORIN

Modelos compatibles:
T830018 series, T830026 series



ENVÍOS A TODO EL PERÚ

Ofrecemos amplia cobertura



TR103015Q

Manguera retráctil de 3/8"

- ▶ Longitud de manguera: 15 m
- ▶ Marca: Torin Big Red



Manguera adicional

AHC-32-1

Manguera retráctil de 3/8"

- ▶ Longitud de manguera: 10 m
- ▶ Manguera adicional: 2.15 m



TR107115

Manguera retráctil de 3/8"

- ▶ Tamaño de manguera: 3/8"
- ▶ Presión máxima: 250 PSI
- ▶ Longitud de manguera: 15 m
- ▶ Manguera adicional: 1 m
- ▶ Marca: Torin Big Red





TRHS-A0031

Kit compresímetro
gasolinero



TRHS-A3453

Kit compresímetro de
aceite



TRHS-A1018

Kit compresímetro
gasolinero



TRHS-E1245

Kit de extractor de filtros



TRHS-A1998A

Kit de purgador de frenos



TRHS-E3431

Kit de botador de rotulas



TRHS-E0026

Kit de extractor de anillos internos



TRHS-E3318B

Kit de extractor de caliper

Herramientas

DESENLLANTADORA MANUAL

J VEGA IMPORT S.A.C

Desenllantadora Manual

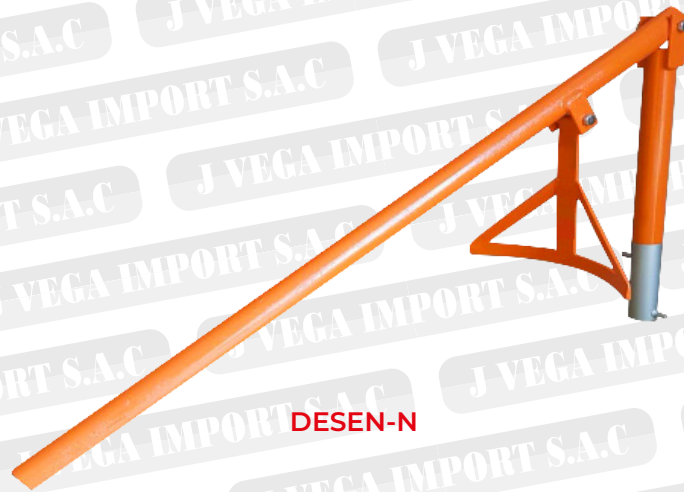

Modo de uso



ENVÍOS A TODO EL PERÚ

Ofrecemos amplia cobertura

SKK-124

► Aro compatible:
15" - 24.5"



SJD-21

► Aro compatible:
15" - 24.5"



Modo de uso



DESENLLANTADORA MANUAL

DESEN-01

Desenllantadora



Modo de uso



Desenllantadora neumática / eléctrica



TMD-A

Desenllantadora neumática

- ▶ Velocidad: 5 veces/min
- ▶ Presión de trabajo: 0.8-1.2Mpa
- ▶ Aros: R17.5, R19.5, R22.5
- ▶ Peso: 50 kg



TMD-E

Desenllantadora eléctrica

- ▶ Velocidad: 5 veces/min
- ▶ Voltaje eléctrico: 220 V
- ▶ Aros: R17.5, R19.5, R22.5
- ▶ Peso: 101 kg

TANQUE DE INFLADO

Cheetah de Inflado

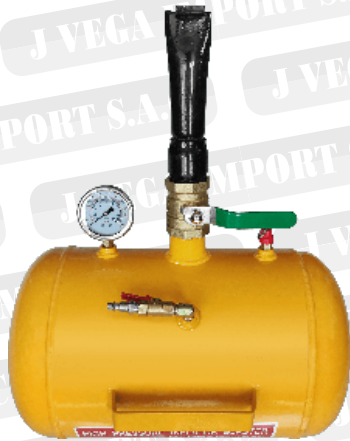

EHG-039-5

Tanque de inflado para neumáticos amarillo

5 GL



EHG-039-8

Tanque de inflado para neumáticos amarillo

10 GL

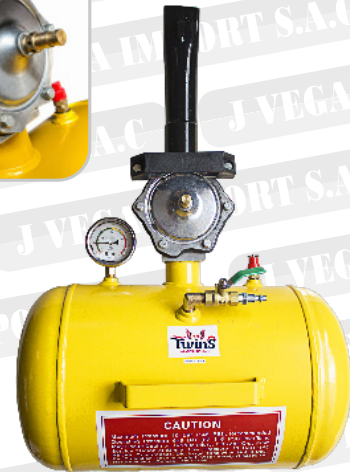

SBST-039D-5

Tanque de inflado con válvula de aluminio

5 GL

0-230 PSI



EHG-S9L

Tanque de inflado para neumáticos

230 PSI

87-116 PSI

9L



EHG-N9L

Tanque de inflado para neumáticos

20 BAR

9L



ENVÍOS A TODO EL PERÚ

Ofrecemos amplia cobertura

TANQUE DE INFLADO



SBST-039A-05

Tanque de inflado para neumáticos amarillo

5 GL

0-230 PSI



SBST-039A-8

Tanque de inflado para neumáticos amarillo

8 GL

0-230 PSI



SBST-039A-10

Tanque de inflado para neumáticos amarillo

10 GL

0-230 PSI



EHG-039R-5

Tanque de inflado rojo para neumáticos

5 GL

87-116 PSI



EHG-039R-8

Tanque de inflado rojo para neumáticos

8 GL

87-116 PSI



EHG-039R-10

Tanque de inflado rojo para neumáticos

10 GL

87-116 PSI

TANQUE DE INFLADO



EHG-039Y-5

Tanque de inflado para neumáticos

5 GL

87-116 PSI



EHG-039Y-8

Tanque de inflado para neumáticos

8 GL

87-116 PSI



XW-5

Tanque de inflado para neumáticos

5 GL

87-116 PSI



XW-5A

Tanque de inflado con válvula de aluminio

5 GL

87-116 PSI



XW-5S

Tanque de inflado con válvula de aluminio

5 GL

87-116 PSI



XW-8A

Tanque de inflado con válvula de aluminio

8 GL

87-116 PSI

TANQUE DE INFLADO



XW-8S

Tanque de inflado con válvula de aluminio

8 GL

87-116 PSI



EHG-039-10

Tanque de inflado para neumáticos

10 GL

Presentación:



XW-10

Tanque de inflado con válvula de aluminio

10 GL

87-116 PSI



XW-12L

Tanque de inflado de aluminio horizontal

12 GL

145 PSI



XW-V12L

Tanque de inflado de aluminio horizontal

12 GL

145 PSI



ENVÍOS A TODO EL PERÚ

Ofrecemos amplia cobertura

Herramientas

CAMILLA PARA TALLER MECÁNICO

J VEGA IMPORT S.A.C



TR6452



TR6454A



TR6455

Herramientas

CAMILLA PARA TALLER MECÁNICO

J VEGA IMPORT S.A.C



Cód.: J21716 40"



Cód.: TRL8001



Cód.: J21719 40"
CAMILLA PLEGABLE



ENVÍOS A TODO EL PERÚ

Ofrecemos amplia cobertura

Herramientas

CAMILLA PARA TALLER MECÁNICO

J VEGA IMPORT S.A.C



Cód.: TR6040Z
CAMILLA PLEGABLE



Cód.: TRH6802-2



Cód.: J121716 40"



ENVÍOS A TODO EL PERÚ

Ofrecemos amplia cobertura

DIBUJADOR DE COCADA

📍 Dibujador de cocada

Mafrisa



VI-5146

Dibujador de cocada
(50 VA / 220V)



VI-5312

Dibujador de cocada (80
VA / 220V)

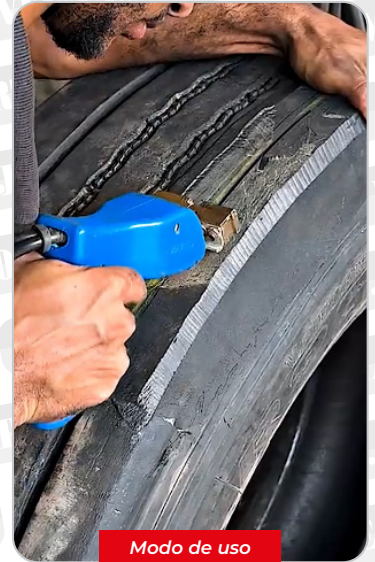

Modo de uso



1351
DELGADO



VI-5255
DELGADO



HSD-T100A

- Voltaje: 220V
- Frecuencia: 60 Hz
- Fuerza: 350W
- 4 Niveles de temperatura



1328
DELGADO



3252 / 5258
GRUESO

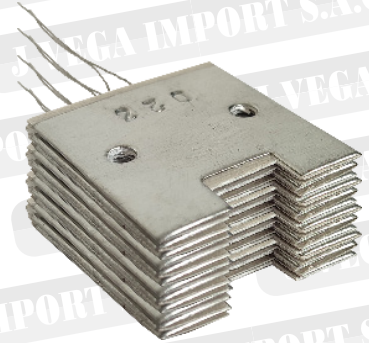

VI-5258

🔴 Dibujador para dibujador de cocada



HSC-BLADES R

- R1: 3-4 mm
- R2: 5-6 mm
- R3: 6-8 mm
- R4: 9-10 mm
- R5: 10-14 mm

Cantidad: 20 uds.



HSC-BLADES W

- W1: 3-4 mm
- W2: 5-6 mm
- W3: 6-8 mm
- W4: 9-10 mm
- W5: 10-14 mm

Cantidad: 10 uds.

CUCHILLAS PARA DIBUJADOR DE COCADA



OKR-3.0



OKR-3.5



OKR-4.0

OLD KLOSS

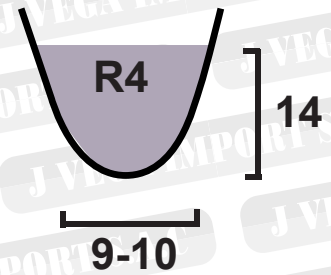

OKR-5.0



OKR-6.0

CÓDIGO	ANCHO	PROF. RECORTE
OKR-3.0	06-08	10 mm
OKR-3.5	08-09	12 mm
OKR-4.0	09-10	14 mm
OKR-5.0	11-14	16 mm
OKR-6.0	17-20	16 mm

CÓDIGO	ANCHO	PROF. RECORTE
OKW-3.5	08-09	12 mm
OKW-5.0	11-14	16 mm
OKW-6.0	17-20	16 mm

OLD KLOSS

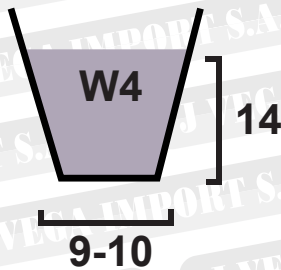

OKW-3.5



OKW-5.0



OKW-6.0

CUCHILLAS PARA DIBUJADOR DE COCADA



FA13-01



FA13-02



FA13-03

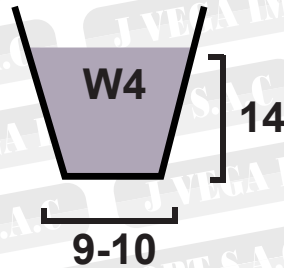

FA13-04



FA13-05



FA13-06

CÓDIGO	ANCHO	PROF. RECORTE
FA13-01	03-04	07 mm
FA13-02	05-06	08 mm
FA13-03	06-08	10 mm
FA13-04	09-10	14 mm
FA13-05	11-14	16 mm
FA13-06	17-20	16 mm
RW5	11-14	16 mm
RW6	17-20	16 mm



W1



W2



W3

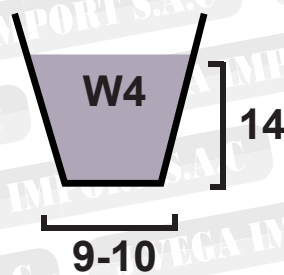

W4



W5



W6

CÓDIGO	ANCHO	PROF. RECORTE
W1	03-04	07 mm
W2	05-06	08 mm
W3	06-08	10 mm
W4	09-10	14 mm
W5	11-14	16 mm
W6	17-20	16 mm

CUCHILLAS PARA DIBUJADOR DE COCADA

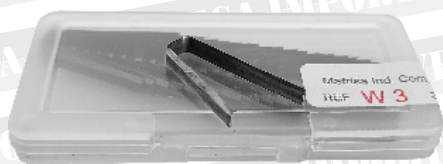

VI-FA13-03
Cuchilla W03 para dibujador
W03 (6-8 mm)

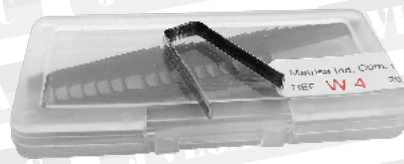

VI-FA13-04
Cuchilla W04 para dibujador
W04 (8-10 mm)

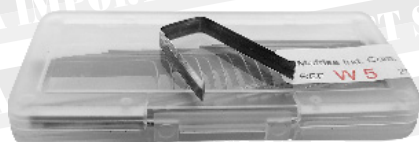

VI-FA13-05
Cuchilla W05 para dibujador
W05 (10-14 mm)

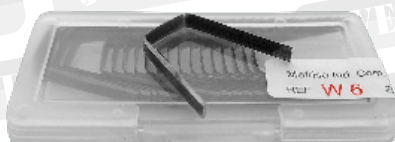

VI-FA13-06
Cuchilla W06 para dibujador
W06 (14-18 mm)



VI-FA13-P
Cuchilla para dibujador
Profundidad: 6 mm

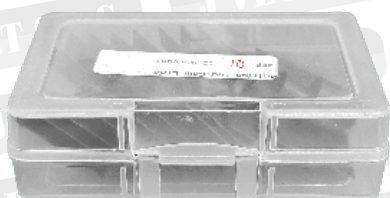

VI-FA13-Q1
Cuchilla para dibujador
Profundidad: 6 mm



VI-FA13-G
Cuchilla para dibujador
Profundidad: 9 mm

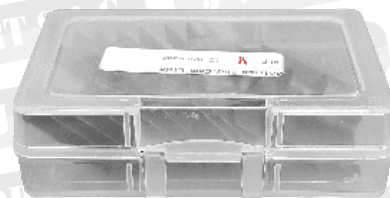

VI-FA13-M
Cuchilla para dibujador
Profundidad: 7 mm



VI-5269

Mango azul de repuesto para dibujador



VI-5267

Seguro de bronce para cuchillas de dibujador



VI-5048

Botón de encendido para dibujador Mafrisa

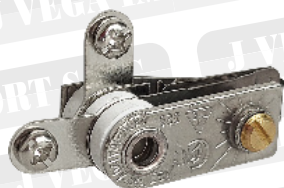

VI-TU

Termostato universal Viluz



VI-RN

Resistencia para numerador Viluz



VI-RS

Resistencia para vulcanizadora Super



VI-RC

Resistencia para vulcanizadora convencional



VI-CBE

Cable de conexión para vulcanizadora Viluz

ETM-18

- Voltaje: 220V
- Fuerza: 480W



ETM-18-L

- Cantidad: 26 letras (A-Z)

Tamaño por unidad

1 cm
5
1.7 cm



ETM-18-N

- Cantidad: 10 números (0-9)

📍 Numerador de Llantas



VI-NE (220V)

Adaptado para placas con letras
Indispensable para el control de flotas

Herramientas

MARCADOR DE LLANTAS Y LETRAS

J VEGA IMPORT S.A.C

Myers

45741

Marcador de llanta
ELRICK 32A 240V



Letras para numerador



45701°



45701E



45701C



45701F



45701V



45701R

Myers

Myers



45733



45701G

J VEGA IMPORT S.A.C



Ubicación de tienda



Tienda La Victoria

Av. Manco Cápac 178 – Lima

994 142 557 / 961 528 219

991 673 601 / 984 481 994



Tienda Carabayllo

Av. Trapiche Mz. A Lt. 15 2da

Et. Urb. Tungasuca – Lima

991 807 134 / 951 158 327

963 062 567 / 991 807 138

¡Síguenos en nuestras redes sociales!

 @jvegaimport

 @parchesparallantas

 Jvegaimport Sac

 @Jvegaimportsac

ventas@jvegaimportsac.com.pe

www.jvegaimportsac.com.pe



¡Escaneame!